

Instruction Manual for Moulded Case Circuit Breakers

Fixed Type
YB3***TF

Adjustable Thermal Magnetic Type
YB3***T

Please retain this manual for future reference. The Manufacturer assumes no responsibility for damages resulting from non-application or incorrect application of the instructions provided herein.

Dorman Smith Switchgear Limited
8 Swinbourne Drive
Springwood Industrial Estate
Braintree Essex
CM7 2YG UK
Tel: +44 (0) 844 225 1063
Fax: +44 (0) 844 225 1064

A49914

Safety Notices

Be sure to read these instructions and other documents accompanying this product. Please familiarise yourself with handling of this product, safety information, and all other precautions before mounting, using, servicing or inspection. In these instructions, safety notices are divided into "Warning" and "Caution" according to the hazard level.

WARNING A warning notice with this symbol indicates that neglecting the suggested procedure or practice could result in lethal or serious personal injury.

CAUTION A caution notice with this symbol indicates that neglecting the suggested procedure or practice could result in moderate or slight personal injury and/or property damage.

Note that failing to observe **CAUTION** notices could result in serious results in some cases. Because safety notices contain important information, be sure to read and observe them.

Mounting Precautions

For detailed mounting dimensions, refer to either the Loadline or System Loadbank catalogues.

CAUTION

- Electrical work should only be undertaken by suitably qualified persons.
- Do not place the product in an area that is subject to high temperature, high humidity, excessive dust air, corrosive gas, strong vibration and shock, or other unusual conditions. Mounting in such areas could cause a fire or malfunction.
- Be careful to prevent foreign objects (debris, concrete, iron powder etc) and rainwater from entering product. These materials inside the product could cause a fire or malfunction.
- Prior to commencing any work on the product, open an upstream circuit breaker or isolator to ensure that no voltage is applied to the product otherwise electrical shock may result.
- For 4 pole breakers, be sure to connect a neutral conductor to the N-phase pole, otherwise an overcurrent may hinder the product from tripping thus resulting in a fire.
- When connecting cable or busbar to the product, tighten terminal screws to the torque specified in this manual, otherwise, a fire could result.
- After conductor connection, do not apply excessive force to the terminals. Otherwise, a fire may result.
- For front-connected breakers, insulate all bare conductors of the line side until the breaker end. If interpole barriers are packed, be sure to use the barriers; moreover, insulate all bare conductors by insulating tape or the like so that the tape overlaps with the barriers. Insufficient insulation may result in short-circuit.
- Do not block the arc gas vents of the product to ensure adequate arc space. Blocking these vents could result in failure of circuit interruption.

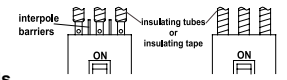

Handling Precautions

WARNING

- Never touch terminals. Otherwise, electric shock may result

CAUTION

- When the breaker trips open automatically, remove the cause, then return the handle to the ON position. Should a fault be interrupted, the breaker must be inspected, otherwise, a fire may result.

Maintenance Precautions

CAUTION

- Service and/or inspection of the product must be done by persons having expert knowledge.
- Before servicing or inspecting the product, open an upstream circuit breaker or the like to isolate all sources of power. Otherwise, electric shock may result.
- Regularly check that the breaker terminal screws are tightened to torque values shown within this manual, failure to do so may result in fire.

Other Precautions

- Do not carry this product by accessory leads, as this may cause damage to the product.
- Unauthorised opening of the breaker cover will invalidate product warranty.
- When installing the product, use wires or conductors, the cross sectional areas of which accommodate the rated current of the product. Using wires or conductors with inadequate cross sectional areas may cause false tripping and overheating.

Packaged Items/Assembly Tools

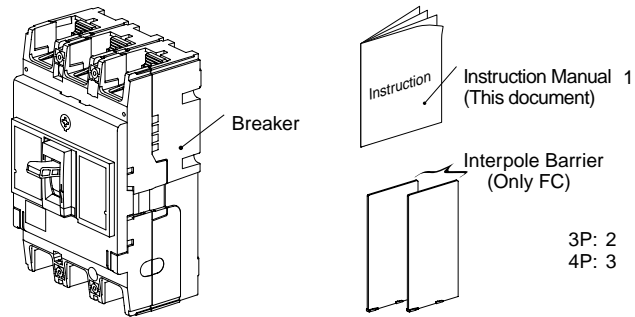

3P: 2
4P: 3

Connections/Poles	Type YB3			
	Qty	Mounting screw	Qty	Connecting screw
Front Connection	3P	2	M4 55	M8 18
	4P	4		
Rear Connection	3P	2	M4 55	M8 25
	4P	4		
Plug-in Connection	3P	2	M4 65	M8
	4P	4		

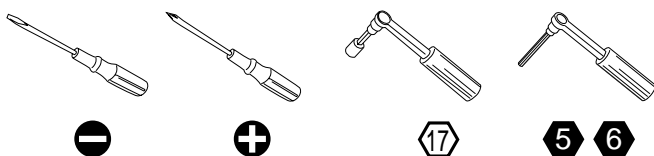

Operating Instructions

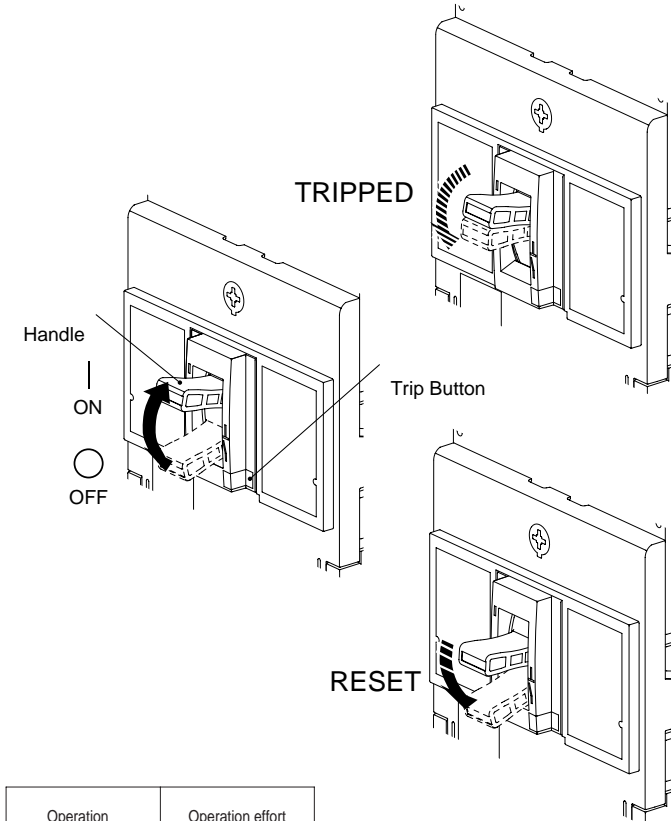

Operation	Operation effort
(OFF) (ON)	53N
(ON) (OFF)	57N
TRIP (OFF)	91N

Fitting Internal Accessories

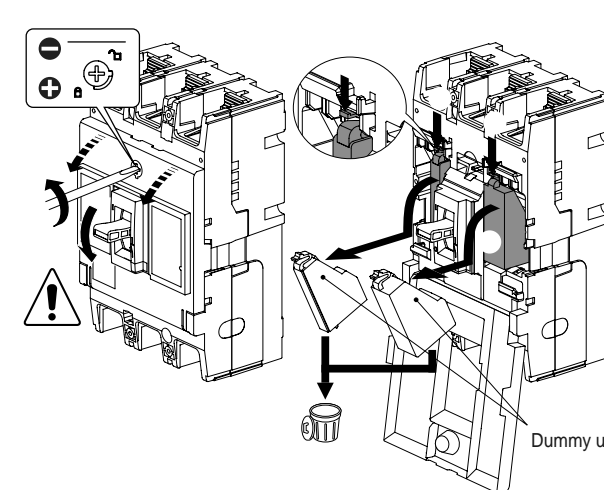

YBAL	Alarm Switch
YBAUX1	Auxiliary Switch
YBST**	Shunt Trip
YBUVR**	Undervoltage Trip

Symbols of Accessories Ring Mark

Auxiliary Switch		Alarm Switch	
a contact	b contact	a contact	b contact
11/AXc-14/AXa	11/AXc-12/AXb	91/ALc	91/ALc - 94/ALa
21/AXc-24/AXa	21/AXc-22/AXb	94/ALa	92/ALb
31/AXc-34/AXa	31/AXc-32/AXb		
41/AXc-44/AXa	41/AXc-42/AXb		

Symbols of Accessories

Shunt Trip power source C1-C2	Undervoltage Trip power source D1-D2
-------------------------------	--------------------------------------

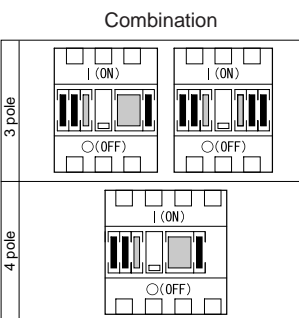

Pull Out Leads on Load Side

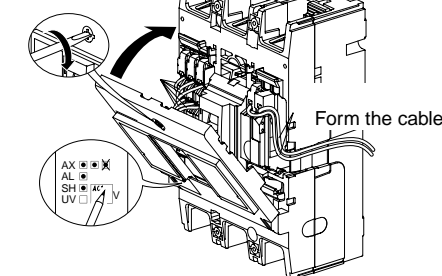

Removal

In case of fitting one (or two) auxiliary switch, fit in an order from a left side-slot.

After fitting, verify the function of the Accessory.

